

MIXED "S" LARGE





MIXED "S"

A double curvature mixed "S" roof tile where eaves and ridge tiles assure design and functionality to provide easy-to-install roofs with the special characteristic beauty of the Mediterranean roofs

A large variety of accessories available to guarantee timeless durability under any kind of building work and satisfy the needs and preferences of all professionals





MIXED "S" LARGE

Double curvature

Its double curvature, eave and ridge joints design and functionality as Arab roofs looking. Mediterranean aesthetics with the easiest fixation.

More breakage resistance

Clays composition and perfect press performance make flexion rates higher than even the Standard ones



Double interlocking

The double interlocking -horizontal and vertical- allows the roof to be more watertight, ensuring its impermeability

Wide range of colors

A roof tile with a wide range of colors and complements to satisfy all professionals' needs and preferences; suitable to all type of roofs (new and aged ones).

Cost reduction

Its large format (10.5 pcs/sqm for Large Mixed and 12.5 pcs/sqm for Small Mixed) and strapping every 5 units allow to reduce installation costs.

TECHNICAL CHARACTERISTICS

Flexural Strength test (EN 538)	Resistance > 1200N
Water Impermeability (EN 539-1)	Complies with level 1
Frost Resistance (EN 539-2)	Complies 150 cycles
Geometric Characteristics (EN 1024)	Flatness / Straightness $\leq 1,5\%$

Dimensions*	A: 470 mm; B: 286 mm; C: 75 mm A: 18.5"; B: 11.26"; C: 2.95"
Pieces /m ² - P./sq.	10.5 - 97
Weight piece	3.85 kg / 8.49 lbs
Longitudinal fit **	396 mm (+7mm; -4mm) / 15.59" (+0.27"; -0.16")
Transversal fit **	230 mm (± 3 mm) / 9.05" (± 0.11 ")
Units per pallet	180 / 240
Weight per pallet	693 kg (1,527.8 lbs) / 924 kg (2,037.1 lbs)
Laying	Straight bond

*The tile dimensions indicated in this chart allow a tolerance of approximately +/-2%
**Theoretic value: this should be re-calculated on site with the tiles that are to be used.



NOTE: during the manufacturing process, handling or transport, small friction can occur on the gloved decorated roof tiles, due to the contact of support of some tiles on others. Such friction doesn't affect the structure of the tile or its quality. It's only perceptible on the hand and, therefore, comply with the guarantee of Cerámica La Escandella.



GUARANTEE

35 YEARS

La Escandella

WARMTH AND DELIGHT IN OUR
MOST MEDITERRANEAN ROOF TILE

COLOURS & FINISHES



PAJA*
(RED CLAY)



Colour variations within one batch, affecting the whole of that batch and produced specifically for aesthetic reasons, are permissible.

For tiles of one single colour, variations in color due to the ceramic process itself are accepted.



RED



JASPEE RED

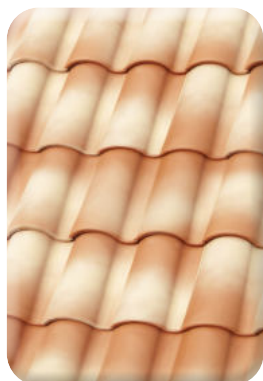

MEDITERRANEA



GALIA



TOSSAL

Note: during the manufacturing process, handling or transport, small friction can occur on the glazed decorated roof tiles, due to the contact of support of some tiles on others. Such friction doesn't affect the structure of the tile or its quality. It's only perceptible on the hand and, therefore, comply with the guarantee of Cerámica La Escandella.



FLAMED PAJA*
(RED CLAY)

MILENIUM

BOURGOGNE

BROWN

SLATE



HISPANIA

MAIGMO*
(RED CLAY)

CASTELL*

LUCENTUM*

AITANA*

* We palletize 1/3 of the tiles with painted eave
The names of the colours shown in the photos, only represent the finishes of the models identified as Mixed "S"

LAI D METHOD

1. Installation will begin with La Escandella Mixed "S" left side courses (rakes) from the eave to the ridge, allowing a 5 cm (2") overhang at the eave. All side course (rake) tiles shall be installed with fasteners typical of the field tile installations.
2. The starter course will begin with a full tile from the eave to the ridge, allowing a 5cm (2") overhang at the eave. The tiles structuring the eave will have to overlap the side course (rake) and fit together one to another. The second course of the tile will lay up directly over the previously installed field tile to the proper exposure and overlapping.
3. See (fig.1) for sequence of installation for fist and succeeding courses of tiles from the eave to the ridge.
4. The right section (vertical terminating end) of the roof can be finished by using either a Half (1/2) Tile (Q16 - Q17) (fig.2) or a Double Tile (Q33 - Q34) (fig.3).
5. For a faster installation and extra ridge ventilation, an Under Ridge Tile (Q70) (fig.2) and/or a Double Under Ridge Tile (Q71) (fig.3), is recommended when reaching the ridge line.

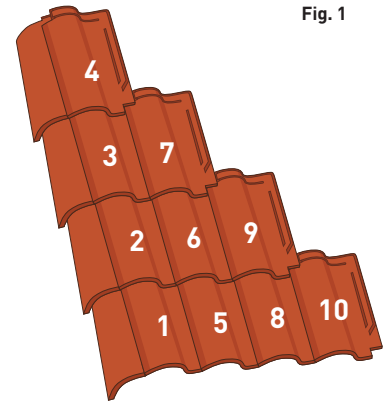

Fig. 1

Half Mixed "S" roof tile laying

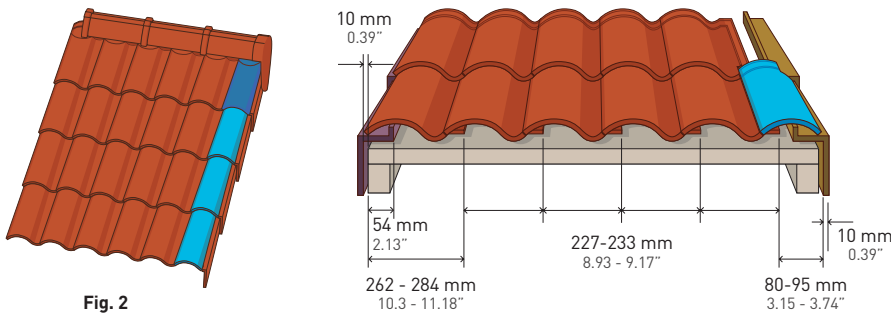

Fig. 2

Double Mixed "S" roof tile laying

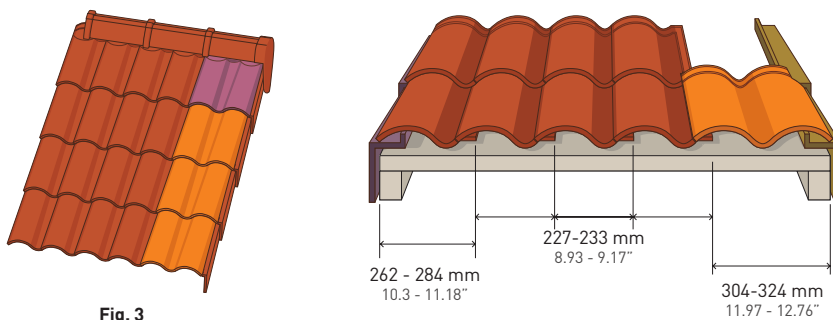

Fig. 3

- Mixed "S" roof tile
- Q10 Straight left side course
- Q11 Straight right side course
- Q16 Half Mixed "S" roof tile
- Q33 Double Mixed "S" roof tile
- Q70 Under Ridge tile
- Q71 Double Under Ridge tile
- Q35 2/3 under ridge tile
- Q37 Double 2/3 under ridge tile

To avoid cutting the field tiles when reaching the ridge line, a 2/3 under ridge tile (Q35 - Q36) can be used in the upper course and closed by using a Double 2/3 under ridge tile (Q37 - Q38).

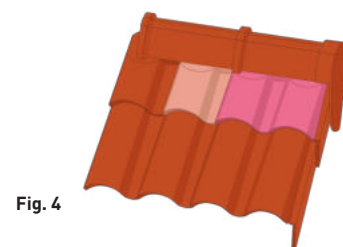

Fig. 4

TIP

Widthwise or lengthwise laid suggested in the technical catalogues are theoretical. The roofer must calculate the real widthwise or lengthwise laid of the tiles to be installed according to the methods defined in the rules in force in our installation manual.

Tiles are manufactured with natural components and fired at high temperature which generates small dimensional variations.

Download the
**INSTALLATION
MANUAL**

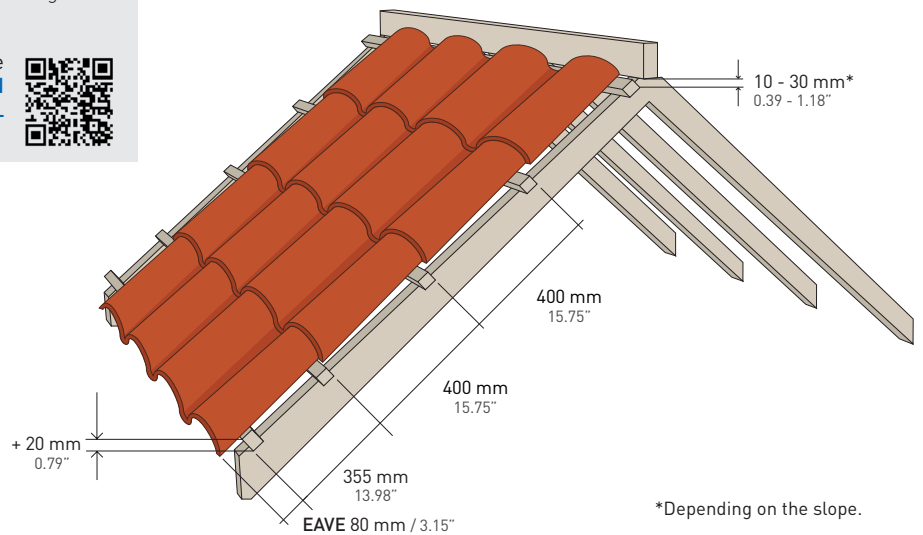

*Depending on the slope.

NOTE: A control line between 3 and 5 rows of tiles (maximum) is recommended.

First course batten should be 20 mm (3/4") higher than all succeeding course battens to provide a vertical alignment and to assure a symmetrical installation

INSTALLATION DETAILS

RIDGE

- Ridge tiles must be installed lap facing away from the prevailing winds, in order to assure water tightness.
- Field tiles at top course should be secured directly either into the deck or top batten with stain-less ring screw nails or similar.
- At the top course of the roof (horizontal terminating end) field tiles can be finished by using either Wedges (Q08) or under ridge tiles (Q70 and Q35).

- All ridges and hips shall be covered with self adhesive Alu-Roll (CAM01, CAMF1, CAM09, CAMF9) or similar approved breathable waterproof underlayment. Underlayment should be secured over the ridge nailer with non-corrosive roofing nails.
- Apply ridge tiles with a minimum overlapping of 5 cm (2") through-out the ridgeline facing away from the prevailing wind-driven rain.

HIP

- Hip tiles must be installed in the same way as in the ridge.
- Field tiles must be mitter cut parallel to the hip line and secured.
- All ridges and hips shall be covered with self adhesive Alu-Roll (CAM01, CAMF1, CAM09,

- CAMF9) or similar approved breathable waterproof underlayment.
- Air should be able to flow through the ridge and hip area. Be sure not to close these off with mortar or similar. Closing them off could result in cracks, peeling off,.. in freezing and thawing cycles.

VALLEY

- Both Valley and eave line channel are particularly vulnerable to water migration and leakage. Valleys should have a clear and unobstructed pathway for quick water drainage.
- Install valley battens on each side of the valley crease. Allu Valley Tape (CAM18), or similar approved adhered waterproof valley underlayment, shall be laid vertically up all valleys in addition to other required underlayment that should be fixed by using glue, resin or similar.
- Where valley intersects with ridge line, apply Allu Valley Tape (CAM18), or similar approved underlayment, which should be covered by the ridge tile. Valley should

- be extended along the eaves to overhang the fascia board by 5cm (2") or over the gutter.
- Tiles should be laid parallel to the valley line, at same relative angle and should overhang the valley battens by at least 10 cm (4").
- Tiles at each side of the valley crease should be laid to provide a minimum 15 cm (6") width gap (tiles should held back minimum 7.5 cm (3") from the center of the valley each way).
- Valley tiles must be secured.
- Proper Valley flashing installation is required to ensure water tightness in order to avoid cracks, peeling off, ...

ACCESSORIES

La Escandella offers a complete line of Large mixed "S" Roof tile accessories, available in any standard color, to customize your roof.

Round ridge / Hip

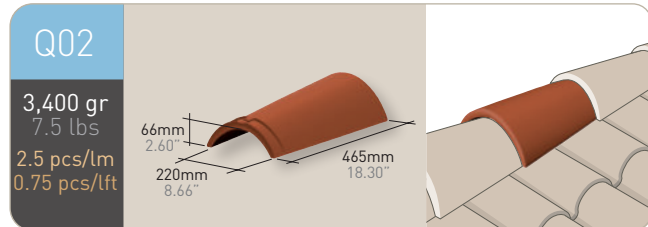

Round ridge end / Hip starter

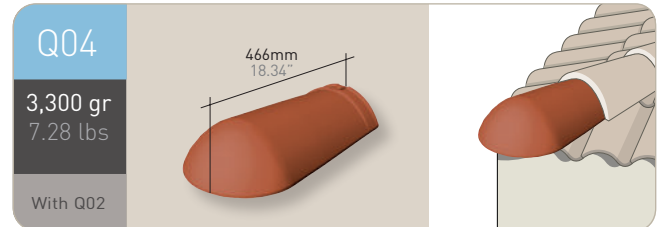

End cap round ridge

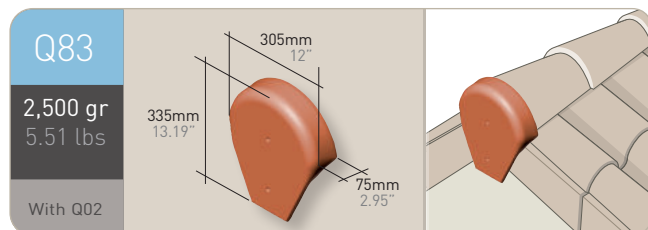

Bardelis end cap / gable end

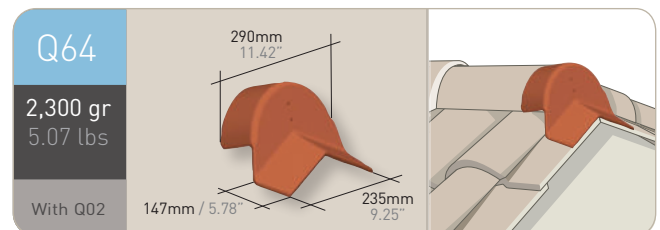

Round 3 way ridge

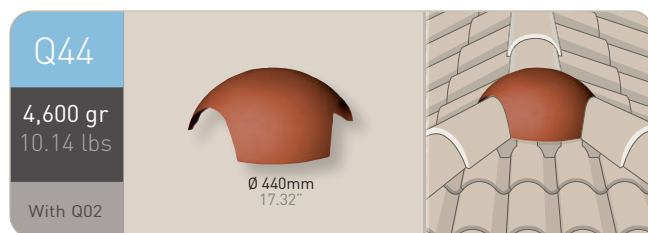

Round 4 way ridge

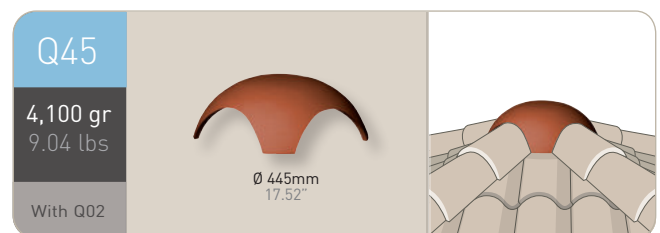

Round 3 way ridge female

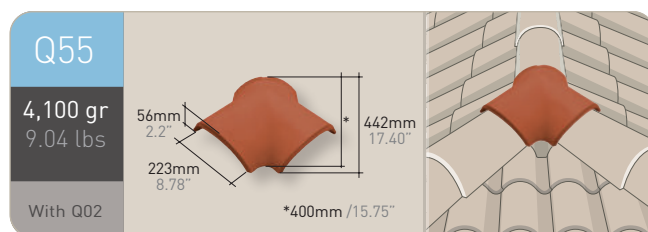

Ridge / hip

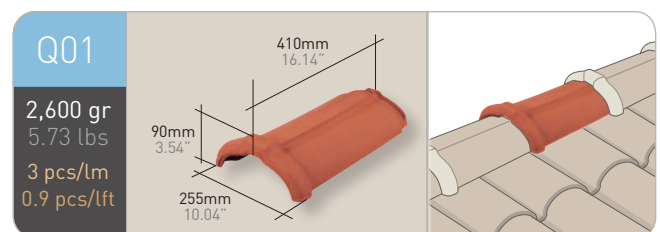

Two way female ridge tile

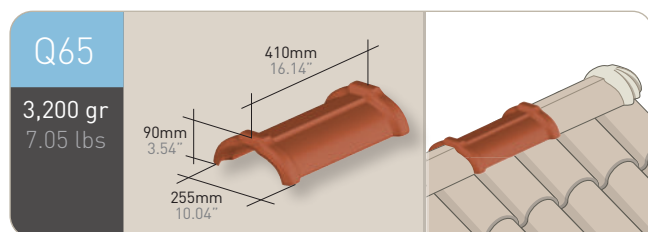

Two way male ridge tile

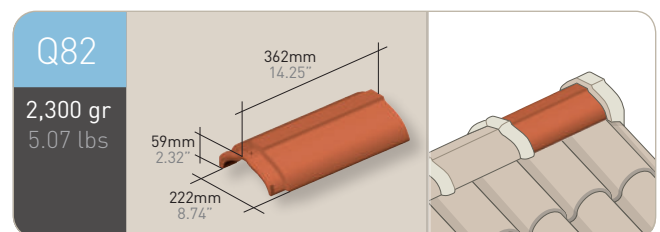

Ridge end / hip starter

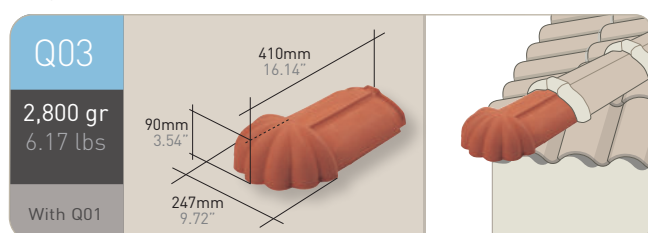

End cap / straight gable end (with Q01)

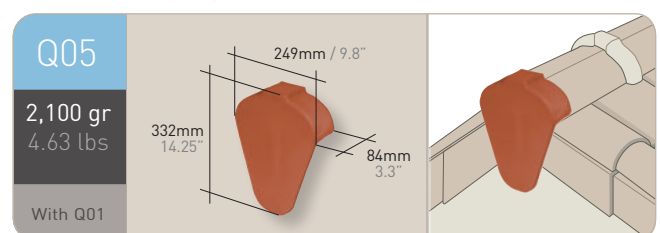

Round end cap / gable end

Q06

1,700 gr
3.75 lbs

With Q01

3 Way ridge

Q07

4,000 gr
8.82 lbs

With Q01

3 Way ridge with slope

Q60

3,700 gr
8.16 lbs

With Q01

3 Way ridge female

Q42

3,700 gr
8.16 lbs

With Q01

4 Way ridge

Q30

4,650 gr
10.25 lbs

With Q01

Universal side course / rake

Q09

3,600 gr
7.93 lbs

2.5 pcs/lm
0.75 pcs/lft

Straight left side course / rake

Q10

3,100 gr
6.83 lbs

2.5 pcs/lm
0.75 pcs/lft

Straight right side course / rake

Q11

3,100 gr
6.83 lbs

2.5 pcs/lm
0.75 pcs/lft

Round left side course / rake

Q12

2,600 gr
5.73 lbs

2.5 pcs/lm
0.75 pcs/lft

Round right side course / rake

Q13

2,600 gr
5.73 lbs

2.5 pcs/lm
0.75 pcs/lft

Bardelis left side course / rake

Q62

2,700 gr
5.95 lbs

2.5 pcs/lm
0.75 pcs/lft

Bardelis right side course / rake

Q63

2,600 gr
5.73 lbs

2.5 pcs/lm
0.75 pcs/lft

ACCESSORIES

Under ridge tile

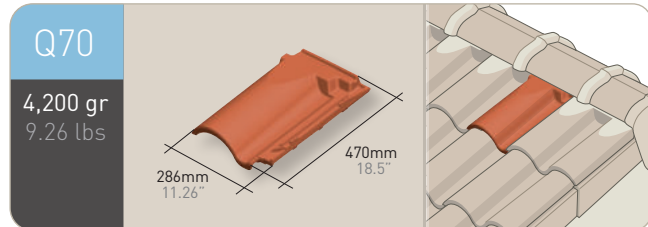

Double under ridge tile

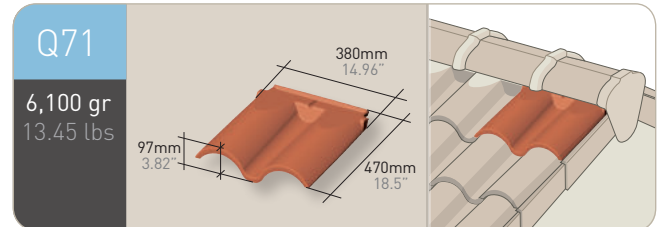

2/3 Under ridge tile

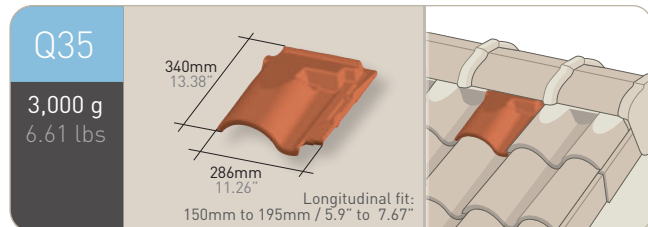

2/3 Double under ridge tile

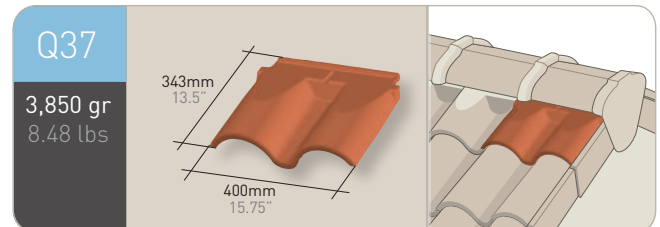

Channel / pan curved eave tile

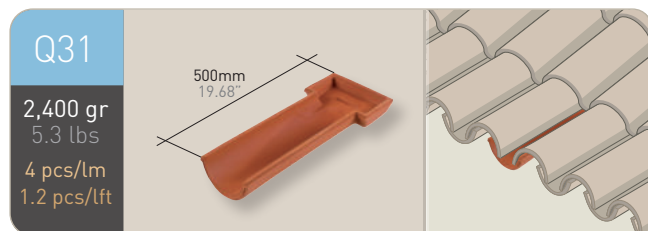

Ridge / cover curved eave tile

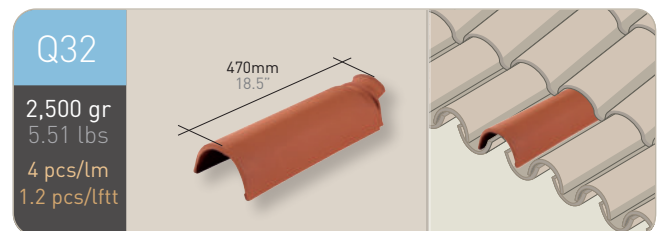

Ridge / cover eave with same slope

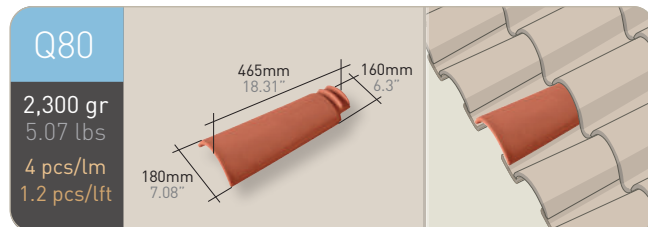

Channel / pan eave with same slope

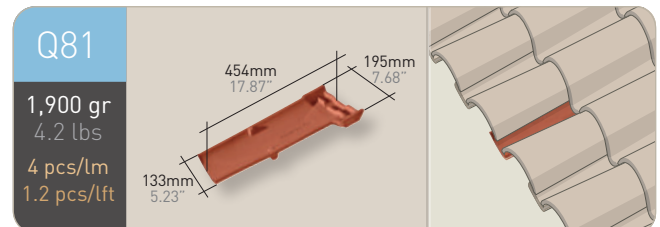

Half large Mixed "S" tile

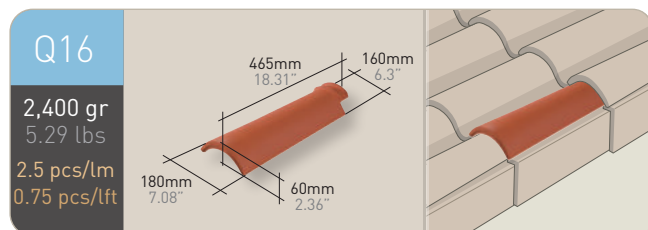

Double large Mixed "S" tile

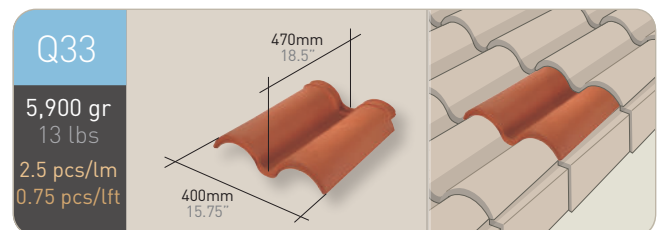

2/3 Large Mixed "S" tile



Large Mixed "S" ventilation tile

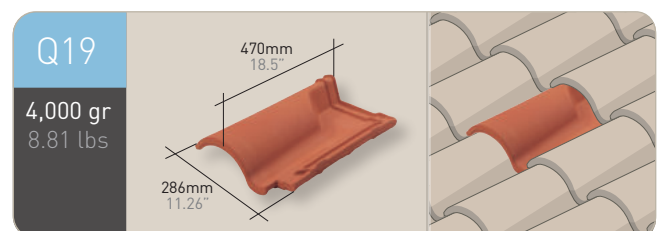

Chimney support Large Mixed "S" tile

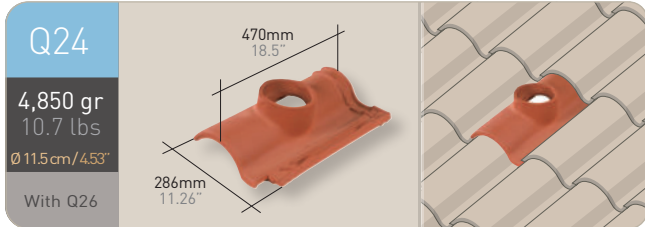

Chimney support Large Mixed "S" tile

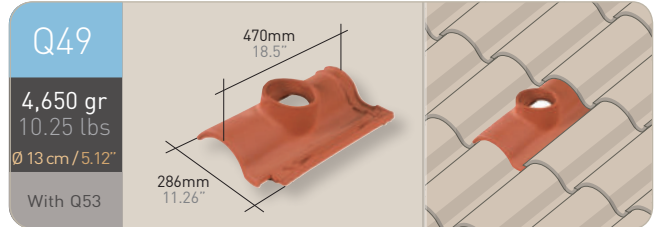

Chimney support Large Mixed "S" tile



Large Mixed "S" glass tile / skylight

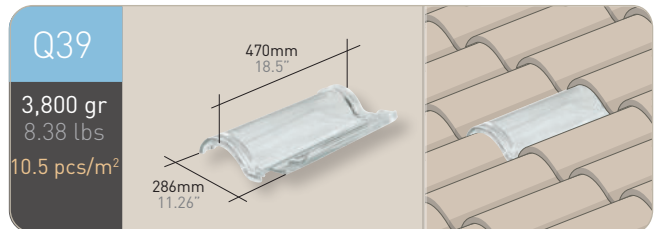

Wedge

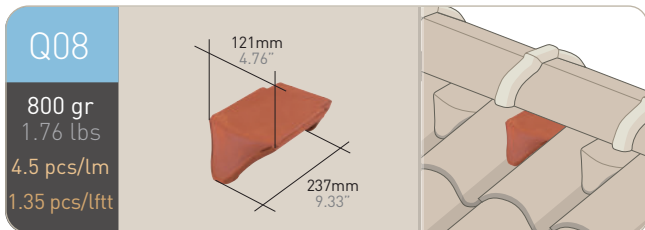

Bird stopper

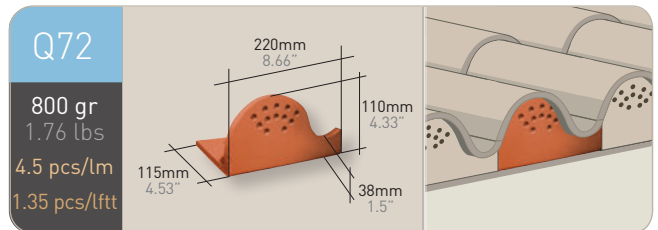

Chimney / pipe cover



Chimney / pipe cover



Chimney / pipe cover



Round corner (11 pieces)

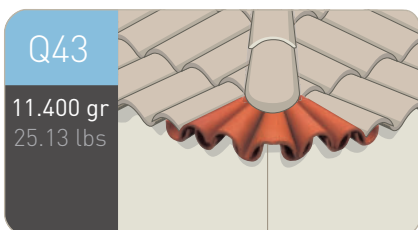

Round corner (3 pieces)

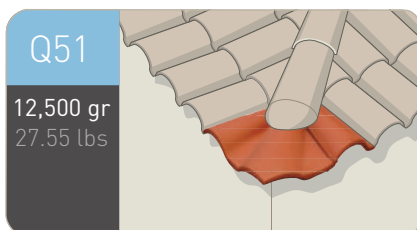

Coronación bellota

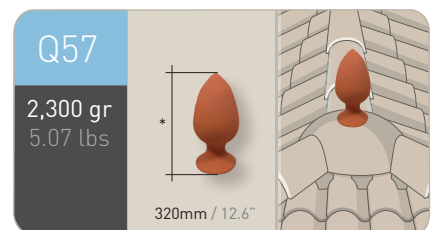

Small Piruli

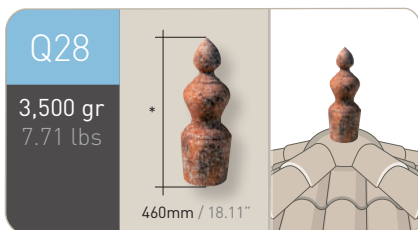

Large Piruli

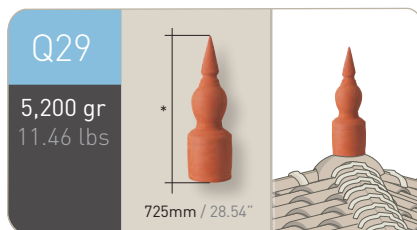

ROOF ACCESSORIES FOR VENTILATED ROOFS

La Escandella offers a wide range of non-ceramic accessories which help finish off any type of roof. From waterproofing to ventilation, fixing and batten installing, safety implementation and multiple profiles can be found here. (Ask for wider range in last Price List).

CAM01 / CAMF1
Alu-Roll With Micro Cut



Width: Several sizes
Colours: Red, brown, black.

CAM08 / CAMF8
Alu-Flex

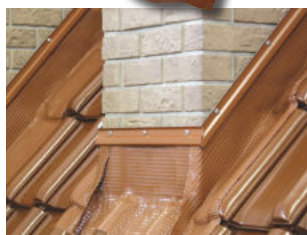
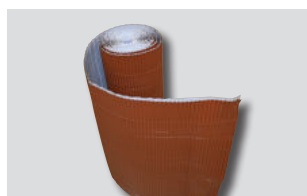

Width: Several sizes
Colours: Red, brown, black.

CAM09 / CAMF9
Alu-Roll Membrane



Width: Several sizes
Colours: Red, brown, black.

CAM18
Alu-Valley Tape

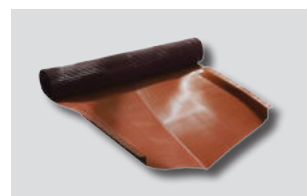

Width: 50 mm / 1.96"
Colours: Red, black, brown.

CAM65 / CAM21 / CAM52 / CAM53
Waterproof membrane

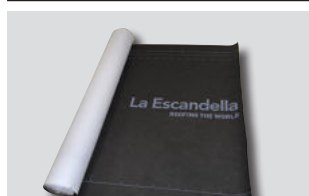

Dimensions: 1,5 m x 50 m / 1.64 yd x 54.68 yd
Weight: several weights.

CAM27NEW / CAM07
Ridge Tile Hook



Colours: Red, brown, black.

CAM05 / CAM010 / CAM51
Ridge Batten Bracket

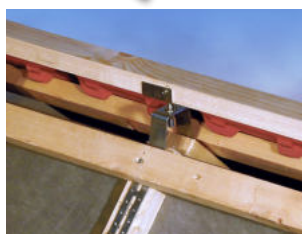
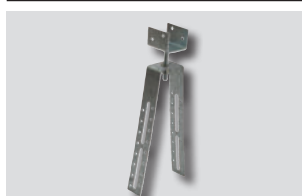

Dimensions: Several sizes.

CAM16
Eaves Ventilation Comb



Dimensions: 6cm x 1m / 2.36" x 39.37"
Colours: Red, brown, black.

MORE INFO
ON THE
WEBSITE



CAM26
Universal clip for roof tiles with
lace

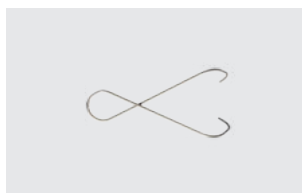

CAM62
Eave hook/clip for wooden
batten



TECHNICAL INFORMATION

SLOPES / PITCHES

The minimum pitch standard recommendations should always be followed (see values in the referral table). On all pitches below the standard recommended minimums, or in regions where ice dams may occur, a waterproof underlayment on the entire deck **MUST** be applied. Most problems with water-shedding roof installations occur from water that migrates through the joints of the tiles through capillary action, wind-driven rain, and runoff or ice damming. Because of this possibility, the underlayment is critical to the success of the roof.

	WITHOUT UNDERLAYMENT				WITH UNDERLAYMENT			
	ZONE 1	ZONE 2	ZONE 3		ZONE 1	ZONE 2	ZONE 3	
Protected	25% / 14°	27% / 15,5°	30% / 17°	Hip < 6,5 m	19% / 10°	21% / 11°	23% / 12°	Protected
Normal	25% / 14°	27% / 15,5°	30% / 17°		21% / 11°	23% / 12°	26% / 14°	Normal
Exposed	33% / 18,5°	37% / 20,5°	40% / 22°		28% / 15°	32% / 17°	34% / 18,8°	Exposed
Protected	28% / 16°	32% / 18°	36% / 20°	Hip 6,5 m - 9,5 m	22% / 12°	24% / 13°	26% / 14°	Protected
Normal	28% / 16°	32% / 18°	36% / 20°		24% / 13°	27% / 15°	31% / 17,5°	Normal
Exposed	35% / 19,5°	39% / 21,5°	43% / 23,5°		30% / 17°	33% / 18°	37% / 20,5°	Exposed
Protected	32% / 18°	35% / 19,5°	40% / 22°	Hip 9,5 m - 12 m	23% / 12°	26% / 14°	30% / 17°	Protected
Normal	32% / 18°	35% / 19,5°	40% / 22°		27% / 15°	30% / 17°	34% / 18,8°	Normal
Exposed	42% / 23°	45% / 24,5°	50% / 26,5°		36% / 19°	39% / 21°	43% / 23,5°	Exposed

PROTECTED LOCATIONS: hollow area which is surrounded by hills that protect the hollow from the winds in all directions..

NORMAL LOCATIONS:: Flat area, plateau with minimal elevation changes.

EXPOSED LOCATIONS: Places open to strong winds, coastal areas (up to 5 km / 3 miles from the shoreline), islands or narrow peninsulas, estuaries or closed bays, narrow valleys, isolated mountains, mountain passes and earthquake zones.

NOTE: For hips MORE than 12m long (39.4'), a waterproof underlayment on the entire roof deck **MUST** be applied and the ventilation underneath must be reinforced (check with the manufacturer).

FIXATION

The slope of a roof determines the level of fixation of the tiles required. The fixation of the tiles may be necessary to prevent the sliding of the roof tiles or to prevent their lifting by the effect of the air. **In eaves, right and left side course, lines of ridge, valleys, encounters with vertical walls and other singular points, all the pieces will be fixed.** For all other parts, the level of fixation will depend on the pitch.

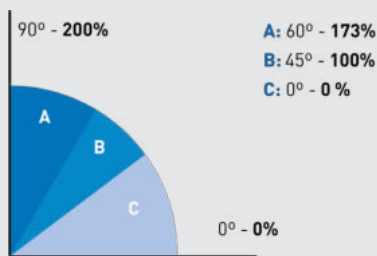

A: Every roof tile should be securely fastened by nailed, screwed, clipped...

B: Roof tiles will be fixed at least once every two or three, depending on the exposure of the roof and the height of the building.

C: The roof tiles shall be fixed at least in the proportion of one in five from a horizontal line, initiating fixation by rows alternately and regularly on the battens.

In case of high wind exposure, all roof tiles must be fixed.

VENTILATION

Ventilation is one of key elements to assure a good hygrothermal behavior of the roof and preservation of the roof structure. The key to a good and well preserved roof is a good ventilated roof. Proper installation of Ventilation tiles combined with ventilated roof can result in energy savings, in a more energy efficient home.

Air should be able to flow through the eave and ridge; be sure not to close these off with cement, mortar or similar. Eave and ridge areas should be protected to help minimize the access of birds and vermin infiltration.

A free flowing ventilation area must be provided through the roof deck. This ventilation should be evenly distributed throughout the roof space to eliminate any dead air space.

La Escandella recommends a minimum of 1 ventilation tile (Q19) for every 7 m² (1.32 vent tiles per 100 sq ft.) and with a minimum of 2 ventilation tiles per roof surface, installed on the upper part of the roof.

Using a proper ventilation system is the best way to avoid moisture in a roof, that could cause peeling, cracking and other defects on the tile.

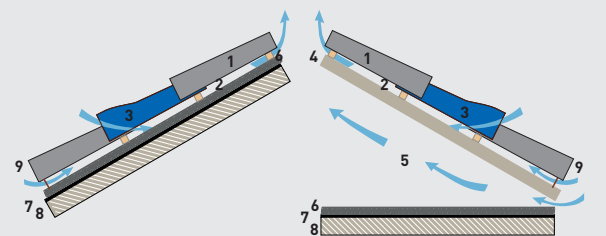

NON-VENTILATED ROOF

1. Roof tile
2. Micro-ventilation void
3. Ventilation roof tile
4. Rafter
5. Attic

VENTILATED ROOF

6. Heat insulation underlayment
7. Waterproof underlayment material
8. Frame
9. Eaves ventilation comb / bird stop

La Escandella warranty will be honored when installation is in strict accordance with local building codes, particularly to those referring to the ventilation of the deck and minimum slope requirements. Clay roof tiles should always be installed in full compliance with the local building codes and good tiling practice. For each country, please refer to local building codes.



www.laescandella.com



Colour Shall be Harmonized but clay tiles are a natural product and some shade variations between individual pieces enhance their beauty and should be expected. All Tiles should be blended regardless of the number of colours supplied. Colours of the tiles shown in this catalogue can not faithfully reflect the colours of the ceramic tiles.

On their products, La Escandella has right to make changes in dimensions, fittings, weight & units per pallet, without previous notice. For more information, please contact your Sales Representative or our Customer Service.

This catalogue, printed in October 2022, replaces the existing ones.